

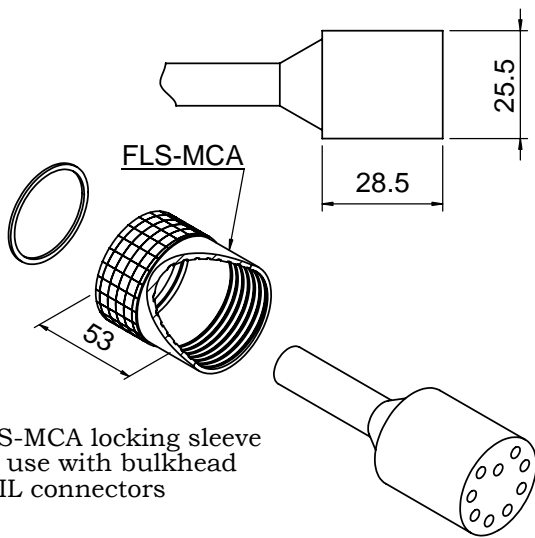

**MC-IL9F**

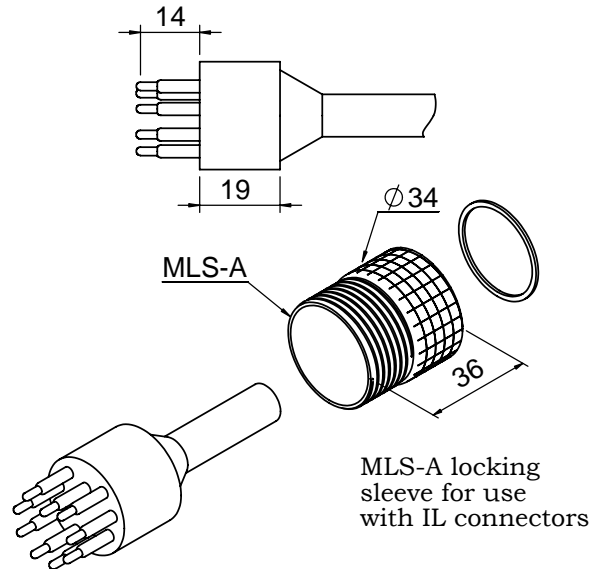

**MC-IL9M**



**MC-BH9F**

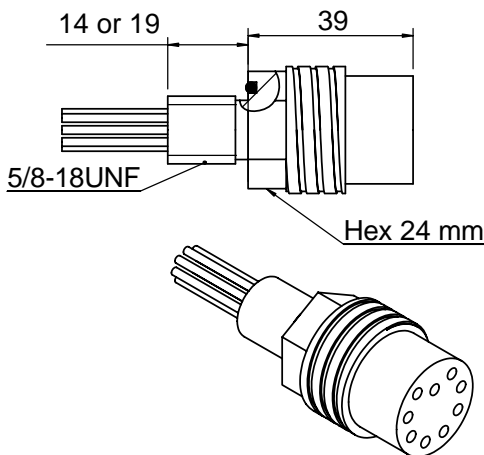

**MC-BH9M**

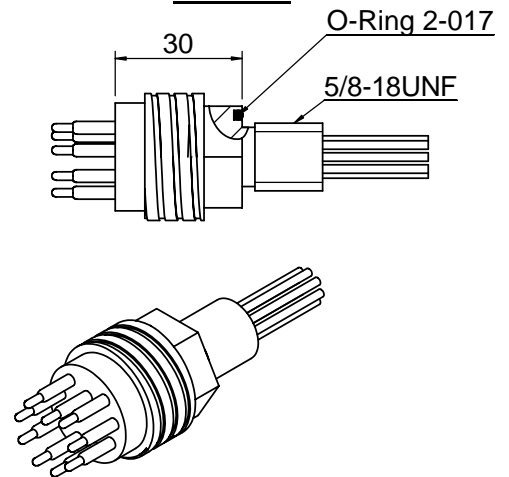

**PIN LAYOUT (FEMALE)**

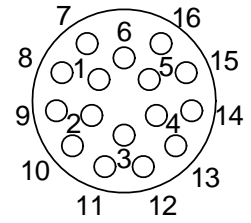
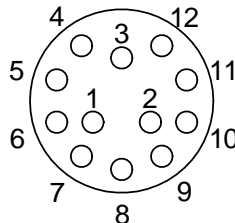
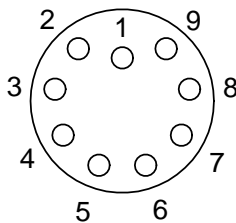



**Mini-Connector (MC) Series 9-16 pins**

Operation Specifications

Max Current	8A
Max Voltage	300V
Insulation	>200megaohm
Contacts	<0.01 ohm
Matings	>750
Temperature	-5C - +65C
Depth	>600 bar

Material Specifications

Molding	Low Carbon Neoprene
Bulkhead	Brass, 316 Stainless, Titanium
Contacts	Gold plated per MIL-G 45204 Type II, Grade D, Class 00
Pin	Phosphor Bronze
Sockets	Beryllium Copper
Location Pin	316 Stainless
O-ring	2-014 Nitrile
Locking Sleeve Material	Delrin
Locking Sleeve Type:	FLS-MCA, MLS-MCA
In-line cable	60cm, AWG 20 (0.5mm <sup>2</sup> ) 26/34 stranding
BH leads	30cm, AWG 20 Teflon, (0.6mm <sup>2</sup> ) 19/32 stranding

Cable Diameter and Current

Color Code

Contact Manufacturer

