

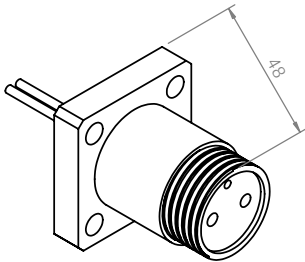

FCR2002F

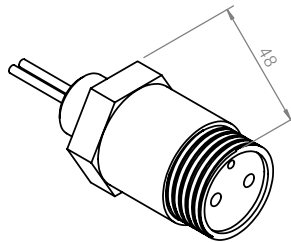

BCR2002F



IL4M

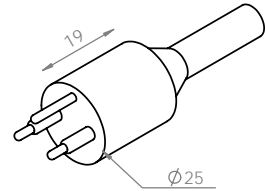

FCR2002M

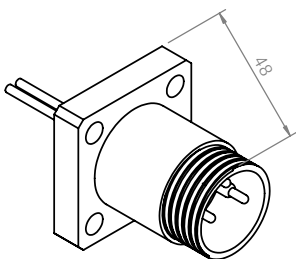

BCR2002M

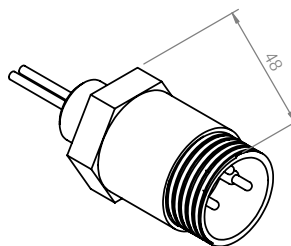

IL4F

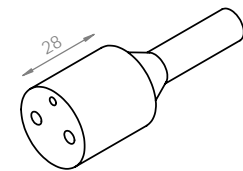

CONTACT LAYOUT (FEMALE)

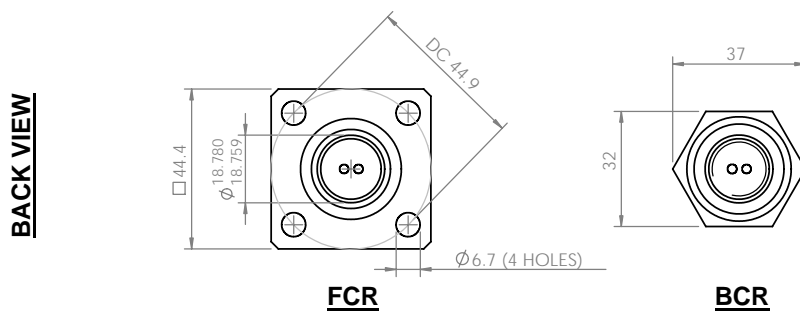
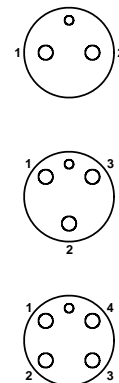
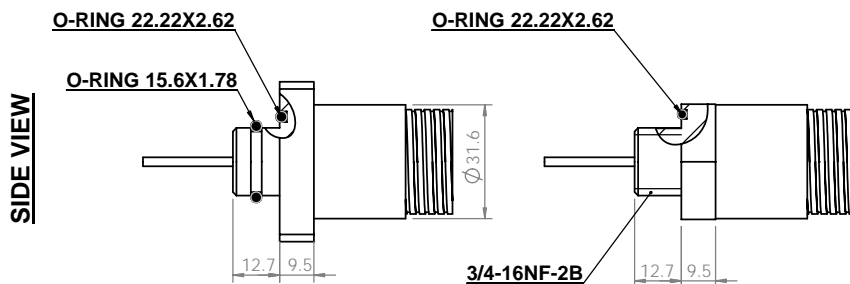

LS2000 Locking Sleeve

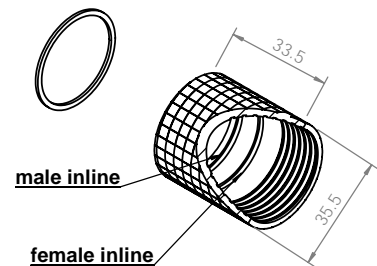

BULKHEAD (SECTION VIEW)

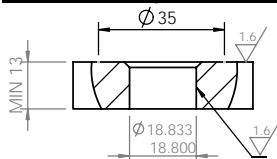



Metal Shell 2000 Series 2-4 pins

Operation Specifications

Max Current	12A
Max Voltage	600V
Insulation	>250megaohm
Contacts	<0.01 ohm
Matings	>750
Temperature	-5C - +65C
Depth	>600 bar

Material Specifications

Molding	Low Carbon Neoprene
Bulkhead	316 Stainless, Titanium
Contacts	Gold plated per MIL-G 45204 Type II, Grade D, Class 00
Pin	Phosphor Bronze
Sockets	Beryllium Copper
Location Pin	316 Stainless
O-ring - FCR	13.0 X 1.5, 19.0 X 1.5 Nitrile
BCR	2-017 Nitrile
Locking Sleeve Material	Delrin
Locking Sleeve Type	FLS-A (female), MLS-A (male)
In-line cable	60cm, AWG 18 (0.82mm ²) 16/30 stranding
BH leads	30cm, AWG 18 Teflon, (0.97mm ²) 19/30 stranding

Cable Diameter and Current

Color Code

2 cond OD 6.0mm 8A	1-black, 2-white
3 cond OD 6.7mm 8A	1-black, 2-white, 3-green
4 cond OD 7.0mm 8A	1-black, 2-white, 3-red, 4-green

Part numbers:

FCR2002F	Flange female 2	FCR2002M	Flange male 2
FCR2003F	Flange female 3	FCR2003M	Flange male 3
FCR2004F	Flange female 4	FCR2004M	Flange male 4
BCR2002F	Hex female 2	BCR2002M	Hex male 2
BCR2003F	Hex female 3	BCR2003M	Hex male 3
BCR2004F	Hex female 4	BCR2004M	Hex male 4

