

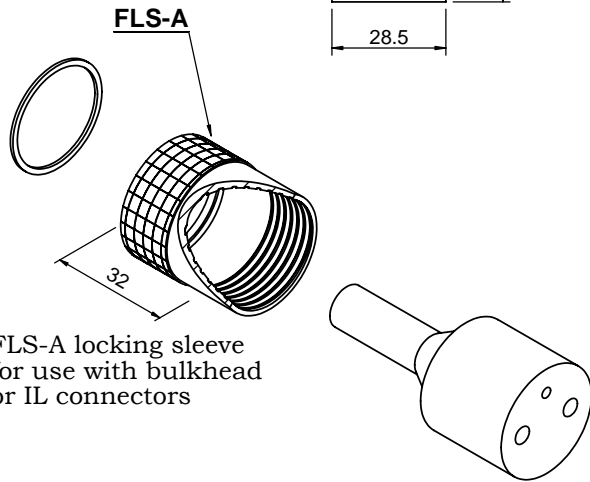

**SC-IL2F**

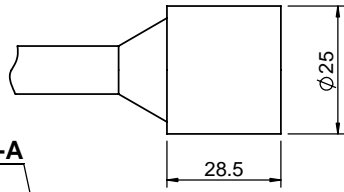

FLS-A locking sleeve for use with bulkhead or IL connectors

**SC-IL2M**

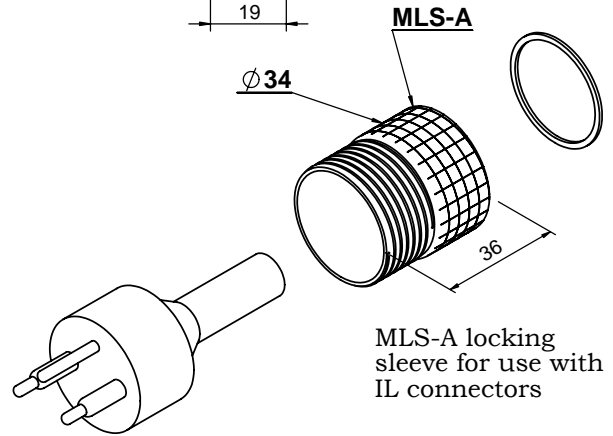
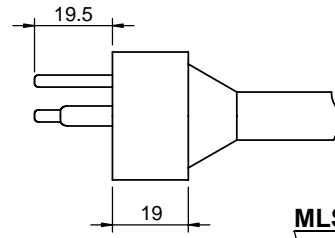

MLS-A locking sleeve for use with IL connectors

**SC-BH2F**

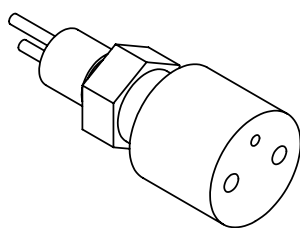
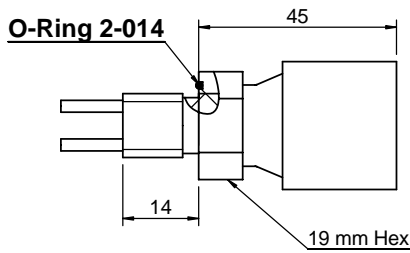

**SC-BH2M**

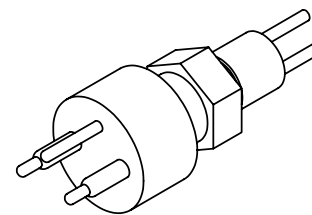
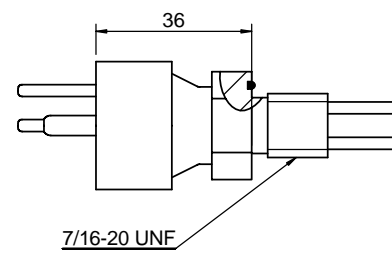

**PIN LAYOUT (FEMALE)**

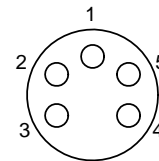
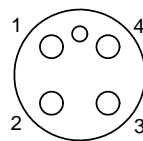
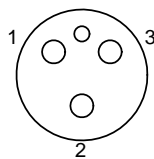
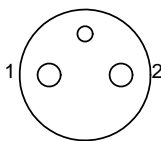



**Standard Circular (SC) Series 2-5 pins**

Operation Specifications

Max Current	12A
Max Voltage	600V
Insulation	>250megaohm
Contacts	<0.01 ohm
Matings	>750
Temperature	-5C - +65C
Depth	>600 bar

Material Specifications

Molding	Low Carbon Neoprene
Bulkhead	Brass, 316 Stainless, Titanium
Contacts	Gold plated per MIL-G 45204 Type II, Grade D, Class 00
Pin	Phosphor Bronze
Sockets	Beryllium Copper
Location Pin	316 Stainless
O-ring	2-014 Nitrile
Locking Sleeve Material	Delrin
Locking Sleeve Type:	FLS-A, MLS-A
In-line cable	60cm, AWG 18 (0.82mm <sup>2</sup> ) 16/30 stranding
BH leads	30cm, AWG 18 Teflon, (0.97mm <sup>2</sup> ) 19/30 stranding

Cable Diameter and Current

Color Code

2 conductor OD 7.5mm	12A	1-Black, 2-White
3 conductor OD 8.1mm	12A	1-Black, 2-White, 3-Green
4 conductor OD 9.0mm	12A	1-Black, 2-White, 3-Red, 4-Green
5 conductor OD 12.2mm	12A	1-Black, 2-White, 3-Red, 4-Green, 5-Orange

