

CONTACT (FEMALE)

VMK-FS

VMK-MP

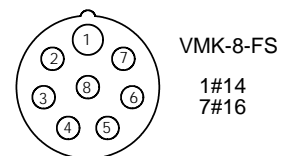

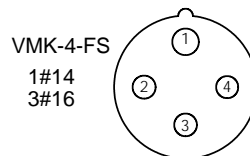
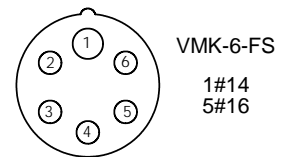
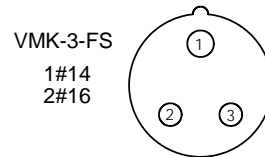
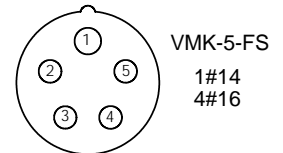
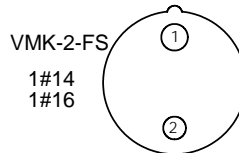
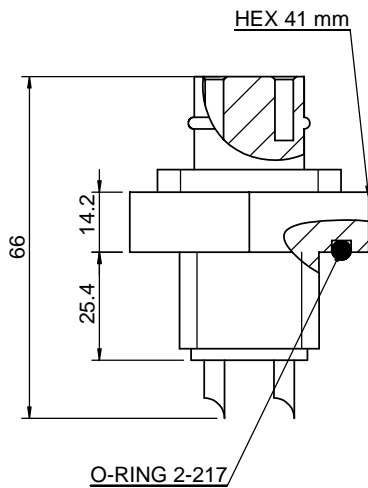

Rubber Molded (VM-K) Series 2-8 pins

Operation Specifications

Max Current	12A
Max Voltage	600V
Insulation	>250megaohm
Contacts	<0.01 ohm
Matings	>750
Temperature	-5C - +65C
Depth	>600 bar (10K PSI) mated
Mating Bulkhead	VSK-BCL

Material Specifications

Molding	Low Carbon Neoprene
Contacts	Gold plated per MIL-G 45204 Type II, Grade D, Class 00
Pin	Brass
Sockets	Beryllium Copper
O-ring (VSK-BCL)	2-217 Nitrile
Locking Sleeve Material	Glass-Reinforced Nylon
Locking Sleeve Type:	FLS-K, p/n 63A-020
In-line cable	60cm, AWG 18 (0.82mm ²) 16/30 stranding

Cable Diameter and Current

Color Code

2 conductor OD 7.5mm	12A	1-Black, 2-White
3 conductor OD 8.1mm	12A	1-Black, 2-White, 3-Green
4 conductor OD 9.0mm	12A	1-Black, 2-White, 3-Red, 4-Green
5 conductor OD 12.0mm	10A	1-Black, 2-White, 3-Red, 4-Green, 5-Orange
6 conductor OD 12.3mm	10A	1-Blk, 2-Wht, 3-Red, 4-Green, 5-Orange, 6-Blue
8 conductor OD 13.5mm	10A	7-White/Black, 8-Red/Black

